

1T9985ELTR | CCTEVO DOWNLIGHT 78

Recessed LED Downlight in a trimless version

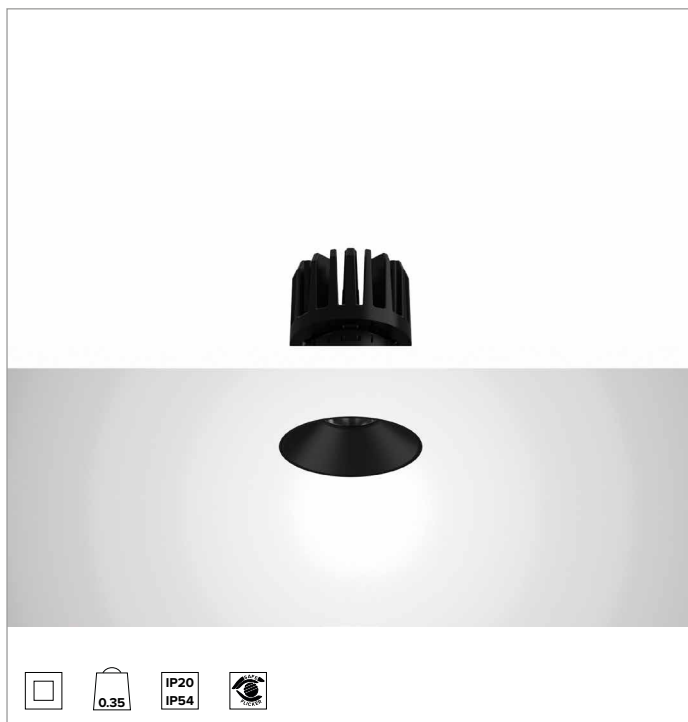

	2700K	H(m)	D(m)	Emax(lx)
	Ra90			54°
Fixture Power	13W	1	1.02	1695
Source Flux	1507lm	2	2.04	424
Fixture Flux	1252lm	3	3.06	188
Efficacy	93lm/W	4	4.08	106
TS1680	Imax=1125cd/klm	Imax	1695cd	5
			5.10	68

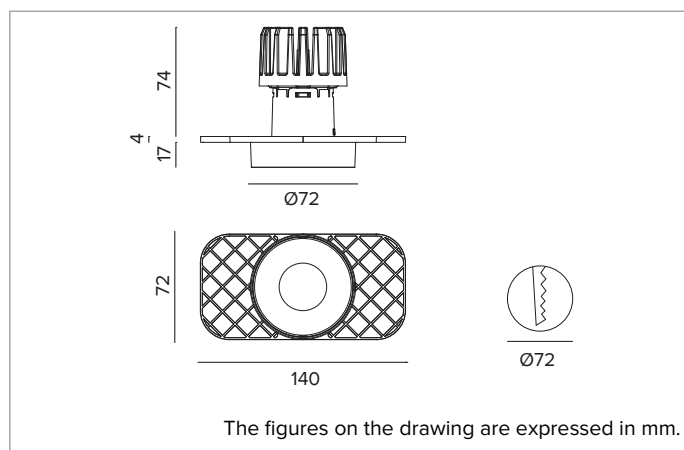

SOURCE

High efficiency Chip on Board LED Ra90. Ra80 on request.

Energy efficiency class: E

Nominal power: 12W

Nominal flux: 1507lm

Colour rendering index: 90

Rf: 92

Rg: 99

CCT nominal: 2700K

Lifetime (L80/B10): >50000h tq +25°C

ILLUMINOTECHNICAL CHARACTERISTICS

WFL Optic: An anodised aluminium reflector and holographic acrylic diffuser screen. UGR<19 and L65<1000 cd/m² (EN 12464-1). IP54 protection for the visible parts of the installed fixture.

Optic: REFLECTOR

Beam angles: WFL

Optical efficiency: 83%

Fixture flux: 1252lm

Luminous efficacy: 93lm/W

Photobiological safety: Compliant with RG1 low risk group

MECHANICAL CHARACTERISTICS

Die-cast black painted anodised aluminium heat sink. Black thermoplastic material structure and a black or white painted cut-off front. Silicone sealing kit for water and dust protection. Trimless version with a load-bearing element for installation and finishing in plasterboard.

Colour and finish: Deep black

Weight: 0.35Kg

Version: TRIMLESS

Degree of protection: IP20 for recessed part

Degree of protection: IP54 for exposed part

ELECTRICAL CHARACTERISTICS

Integrated electronic ON-OFF driver. Luminaire compliant with EN 60598-2-22 for power supply from a centralised emergency system CPSS (Central Power Supply System), not incorporated in the luminaire - high risk areas excluded. The default power and flux are 100% in AC and 100% in DC.

Fixture Power: 13W

Power supply: 220-240Vac 50/60Hz

Insulation Class: CLASS 2

Type of driver / Control: ON-OFF

Driver included: YES

Class F: YES

SAFE FLICKER: PstLM=<1 and SVM=<0.4 (IEC TR 61547-1 and IEC TR 63158), to ensure a more comfortable and safe light

Ambient temperature: 0°C / +25°C

INSTALLATION

Quick tool-free mounting system for false ceiling installation from 0.5 to 30mm.

NOTES

110-277Vac version available on request.

WARRANTY

5 years.

WARNING

Luminaire designed for disposal/recycling at end-of-life. Replaceable (LED only) light source by a professional. Replaceable control gear by a professional.

Due to the technological evolution of the electronic components, the data provided may be updated, and as such, confirmation must be requested during the order process.

Luminous flux and power supply have +/-10% tolerances with respect to the indicated value. tq +25°C (CIE 121).

We reserve the right to make technical changes.

Targetti Sankey S.r.l.
Via Pratese, 164
50145 Firenze - Italy
Tel: +39 055 37911
targetti.com
targetti@targetti.com

CCIAA Firenze
Share Capital:
€ 500.000,00
VAT N. (IT):
01537660480
R.E.A: FI-275656

TARGETTI

1T9985ELTR | CCTEVO DOWNLIGHT 78
 Recessed LED Downlight in a trimless version

Accessories

Mounting System



L mm	Code
2500	1T9606

Anti-fall safety cable to secure the body of the appliance to the building structure.

Emergency Kit



Code
A059

Emergency kit composed of an inverter a LiFePO4 battery and a LED Green indicator. Allows permanent EP emergency use of the fixture it is connected to. The 1h or 3h autonomy can be selected by configuring the fixture. The batteries take 12h to completely recharge. LED Green indicator wired to the inverter through single-core cables L= 800mm. Emergency kit for fixtures that comply with EN 60598-2-22 standard, high risk areas excluded. Battery size 160x54x30 mm. Inverter size 165x40x25 mm.

Due to the technological evolution of the electronic components, the data provided may be updated, and as such, confirmation must be requested during the order process. Luminous flux and power supply have +/-10% tolerances with respect to the indicated value. tq +25°C (CIE 121).

We reserve the right to make technical changes.

Targetti Sankey S.r.l.
 Via Pratese, 164
 50145 Firenze - Italy
 Tel: +39 055 37911
 targetti.com
 targetti@targetti.com

CCIAA Firenze
 Share Capital:
 € 500.000,00
 VAT N. (IT):
 01537660480
 R.E.A: FI-275656

